



The Electricians' Choice

Available in **7.4kW**
Single phase and **22kW**
Three phase.

High-speed charging
with the freedom of
4G connectivity.



SIENA[®]

EASY FIT • SMARTER CHARGE

Product Catalogue 2025



The Electricians' Choice

**LEWDEN'S EV ECOSYSTEM:
THE END-TO-END CHARGING SOLUTION,
FROM INFRASTRUCTURE TO VEHICLE PLUG-IN**

Lewden, a trusted manufacturer of electrical solutions since 1946, introduces SIENA - a smart, efficient, and reliable EV charger for residential and commercial settings in the UK market. As EV adoption grows, SIENA offers an effortless charging experience, backed by Lewden's legacy of quality and innovation. It's more than a charger - it's part of Lewden's complete, end-to-end EV ecosystem, from infrastructure to plug-in.



AC MODE 3 EV FAST CHARGING POINT



TYPE 2 CHARGING SOCKET



TETHERED OR UN-TETHERED OPTIONS



SINGLE PHASE & THREE PHASE



Discover Siena the new way- visualize before installation.



lewden.com

SIENA®

EASY FIT • SMARTER CHARGE

▼ Smart & Efficient

SIENA is designed to be smart, it features dynamic load balancing, app-controlled scheduling, and solar compatibility for cost-effective and efficient charging.

▼ Reliable

Manufactured by Lewden, a trusted name in electrical products since 1946, it stands out for its durability and compliance with UK regulations. It includes built-in safety features like RCD protection, surge protection, and open PEN fault detection, ensuring both safety and long-term reliability.

▼ Easy to Install

The charger comes with a detachable backplate and user-friendly Monta app for simple setup, remote control, and monitoring. The charger is flexible, with tethered and untethered options, designed to suit UK homes.



The Siena EV Charger is designed to make charging your electric vehicle as easy and efficient as possible, whether at home, in workplaces, or commercial settings. With fast 7.4kW single-phase charging for residential use and 22kW three-phase charging for locations with higher power availability, Siena ensures you're always road-ready while saving valuable time. Now equipped with 4G connectivity (factory fitted, optional), the latest Siena models provide enhanced functionality and seamless remote monitoring, a significant upgrade from previous versions. Its sleek, modern design complements any environment, from homes to commercial premises, combining functionality with a minimalist aesthetic. The smooth finish and compact build ensure it not only delivers exceptional performance but also adds a touch of sophistication to your property or business. The Siena charger is a stylish and practical addition for any location.

OZEV APPROVED

Also approved for the international market*

Solar integration for 7.4kW Single Phase charger

Easily integrate with solar panels to use renewable energy for eco-friendly, cost-saving charging.

Enhanced Safety

Advanced safety features like PEN fault protection ensure secure and reliable charging for your EV and home.

Flexible Power Output

Adjustable power settings from 13A to 32A make Siena adaptable to various home electrical systems.

Sleek Design

The Siena charger's modern, streamlined look complements any home while providing efficient charging.

Weatherproof Durability

Built with an IP55-rated enclosure, the Siena charger is designed to withstand outdoor conditions, ensuring reliable performance in all weather.



Easy Fit Unique Backplate Design

The detachable backplate simplifies installation, allowing electricians to securely mount and wire the system with greater precision and ease, reducing the risk of damage during installation and making maintenance straight-forward.

*Approved for installation in Kuwait and Indonesia.

Explore details, installation guides, FAQs and more on the website.



VERSIONS

7.4kW Single phase un-tethered socket outlet

Part Number: 672150

7.4kW Single phase tethered outlet with 5m charging cable

Part Number: 672151

22kW Three phase un-tethered socket outlet

Part Number: 672350

22kW Three phase tethered outlet with 5m charging cable

Part Number: 672351

Quick and Easy

The attached cable allows for fast plug-and-play charging without the need to handle separate cables.

Ready to Use

Always have the charging cable on hand, making it ideal for frequent charging without extra steps.

Flexible Cable Options

Users can select their preferred cable length and easily swap cables if needed.







Customisable Setup

Offers the flexibility to keep the charging area free of cables when not in use, for a more tailored and sleek look.

Control

-  RFID ACCESS CONTROL WITH 2 FOBS
-  SCHEDULING CHARGE TIMES
-  SOLAR PV COMPATIBLE
*Only for 7.4kW Single Phase
-  MAXIMUM OUTPUT CURRENT ADJUSTMENT
-  DYNAMIC LOAD MANAGEMENT
-  ACTION BUTTON
-  ADJUSTABLE LED BRIGHTNESS

Communication

-  4G, WIFI, BLUETOOTH AND ETHERNET COMPATIBLE
-  SMART APP CONTROL
-  OCPP 1.6 CHARGING PROTOCOL
-  DOWNLOADABLE SOFTWARE UPDATES
-  POWER METERING
-  POWERED BY MONTA
-  LEWDEN CONNECT APP

Protection

-  30 mA TYPE A + 6 mA DC FAULT PROTECTION
-  PEN PRODUCTOR FAULT PROTECTION
-  SURGE PROTECTION
-  TAMPER BOUNDARY BREACH
-  OVER CURRENT & UNDER / OVER VOLTAGE
-  OVER TEMPERATURE
-  LOSS OF PROTECTIVE EARTH TO VEHICLE

SIENA[®]

EASY & EFFICIENT INSTALLATION



SUSTAINABLE PACKAGING

Using eco-friendly materials, aligning with our commitment to reducing environmental impact and supporting a greener future.



DRILLING TEMPLATE

Designed to make installation quick and easy, ensuring perfect alignment every time.



EASY FIT BACKPLATE DESIGN

Detachable backplate streamlines installation, enabling precise and effortless mounting and wiring. This safeguards the charger from potential damage during setup and simplifies future maintenance.

VIEW SIENA IN AUGMENTED REALITY



Visualise before installation.



MAX. OUTPUT CURRENT ADJUSTMENT

For installations with limited supply capacity, the charger's output can be adjusted via a rotary switch, set by a technician at commissioning to ensure safe operation without overloading.



EASY DOCKING OF CHARGER

Effortless final installation: simply dock and secure the charger body once all wiring is complete. Ready to go!



SMART CONNECTIVITY

Control your charging through our partner for complete convenience.



Lewden Connect App

Download for quick Wi-Fi / Bluetooth setup and basic configuration, ensuring the charger is all set to power your EV.



Monta App

Offers advanced control and monitoring, allowing customers to manage charging schedules and optimize for efficiency.

Accessories



RFID FOB

Part numbers: 672900

RFID access control - tap the fob for safe and secure, app-free charging.



Split CT Core

Part numbers: 672901

The Siena EV Charger comes with a split-core current transformer (CT) for dynamic load balancing. An Optional split-core CT enables seamless solar integration, allowing the charger to optimise energy use by drawing power directly from your solar system for efficient, eco-friendly charging.

SIENA®

TECHNICAL SPECIFICATIONS

■ Technical Specifications

Part numbers	7.4kW untethered: 672150 7.4kW tethered: 672151	22kW untethered: 672350 22kW tethered: 672351
Rated Input	7.4kW 230VAC 50/60Hz ±10% 22kW 400VAC 50/60Hz ±10%	
Rated output	7.4kW (32A 230V) 22kW (32A 400V)	
Charging Current	Installer adjustable from 13-32A in 9 pre-defined steps	
Charging Protocol	Mode 3	
Output interface	IEC62196-2 type 2 AC charging socket / connector 	
Communications	<ul style="list-style-type: none"> • Wi-Fi 802.11 b/g/n 2.4GHz • Factory-fitted 4G connection with a customer-supplied SIM (Factory fitted, optional extra. Part number: 672902) • RJ45 Ethernet connection 10M/100M Base-T • Bluetooth (for installer configuration purposes) • USB port (For firmware upgrades only) • Open charge point protocol (OCPP1.6) 	
Built in Protection features	<ul style="list-style-type: none"> • PEN conductor fault <207V & >262.2V for 0.2 seconds • Residual Current Fault 30mA type A and DC 6mA with self-test • Over temperature (Stage 1 >80°C / Stage 2 >90°C) • Output overcurrent (A+2 for max output ≤20A) (Ax1.1 for max output >20A & ≤32A) • Input Overvoltage >253V for 4.5 seconds (Phase voltage) • Ground failure (between charge point and vehicle) >70VAC • Surge Protection • Tamper boundary switch 	
Standby Power Consumption	4W	
Measurement Accuracy	±1%	
Overall Dimensions	370h x 210w x 164.5d (mm)	
Shell Construction material	Polycarbonate and ABS	
Ingress Protection rating	IP55	
Impact resistance rating	IK08	
Ambient Operating temp.	-30°C to +50°C	
Weight	7.4kW untethered: 3kg / 7.4kW tethered: 4.5kg 22kW untethered: 4.5kg / 22kW tethered: 6kg	
Incoming cable termination	4-16mm ²	

■ Standards Compliance

Charging System	BS EN IEC 61851-1: 2019 • UK Smart Charging Regulations 2021 (SI1467 inc. Schedule 1 & 2)
Safety Compliance	UK safety regulations 2016 (SI1101) • Low voltage directive 2014/35/EU
Charging Interface	BS EN IEC 62196-2: 2022
EMC Compliance	BS EN IEC 61851-21-2: 2021 • EN IEC62311: 2020 • BS EN IEC61000-6-1: 2019 • BS EN IEC61000-6-3: 2021
PEN fault protection	BS7671: 2018 +A2: 2022 section 722
Communication Technology	EN 300 328 v2.2.2: 2019 • EN 300 330 v2.1.1: 2017 • EN 301 489-1 v2.2.3: 2019 • EN 301 489-3 v2.1.1: 2019 EN 301 489-17 v3.2.4: 2020 • EN 301 489-52 v15.1.1: 2021 • EN 301 908-1 v15.1.1: 2021 • EN 301 908-13 v13.2.1: 2022
RDC-DD	IEC62955: 2018

■ Dimension

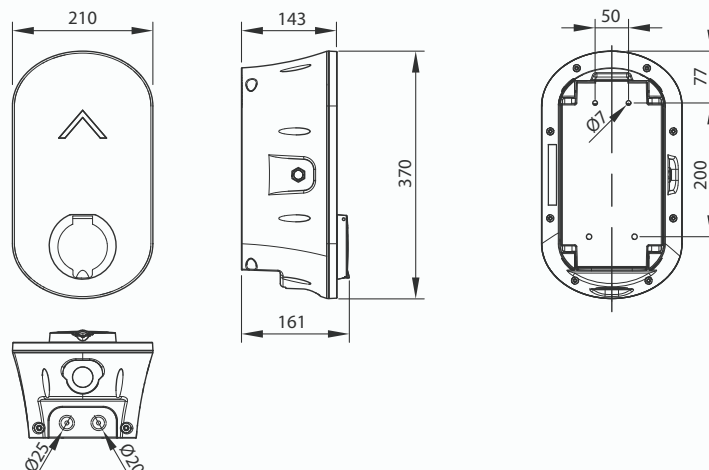

SMART CONTROL



The SIENA EV charger, paired with Monta's powerful app, brings cutting-edge features and user-friendly control, all designed to make home charging simple, efficient, and affordable. With the Monta app, users can easily schedule charging during off-peak hours to save on energy costs, monitor their EV's charging status in real-time, and receive instant updates - all from a smartphone.

SmartCharge

Automaticall optimizes charging during off-peak hours to minimize costs.

Load Balancing

Efficiently distributes power across multiple chargers.

Virtual SolarCharge

Integrates with your home solar panels for eco-friendly power.

PowerBank

Balance the grid and earn energy credits while charging.

Dynamic Pricing & Smart Booking

Save with up-to-date pricing and reserve public chargers.

InstantCharge

Allows guest charging without app downloads.

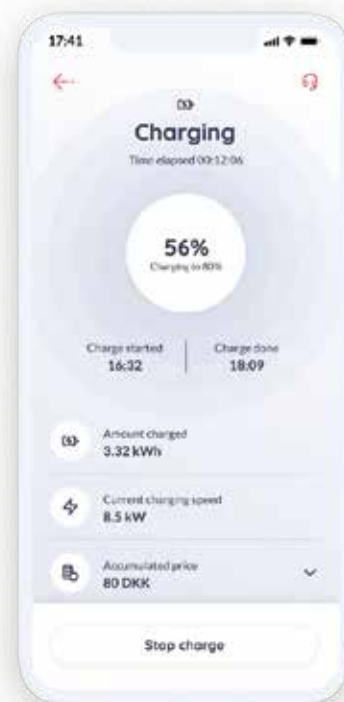

IMMEDIATE & EXTENSIVE TECHNICAL SUPPORT

- **Online Guides**
<https://monta.com/en/help-center/>
- **Customer Contact**
<https://monta.com/en/contact/>
- **Within Monta App**
</me/support>

Connecting all dots in the EV Ecosystem



100A DP metal fused switch

- Available in choices of 63A, 80A, 100A.



SLM2-MS

- Available in 2 module enclosure complete with 100A DP Main Switch - suitable for domestic use. Also available in 4 module enclosure for commercial use.
- Ingress rating IP20 IK07.
- Designed for use with 16mm² & 25mm² double insulated meter tails type 6181Y.



Distribution terminals

- 6 different colour-coded terminals for quick identification of phase, neutral, earth and functional Earth connections.



Main Consumer Unit

- Variety of solutions in our extensive Consumer units range. Choose from Dual RCD solutions, RCBO solutions, RCD Incomer solutions, Dual Tariff boards, Retrofit surge protection range and more.

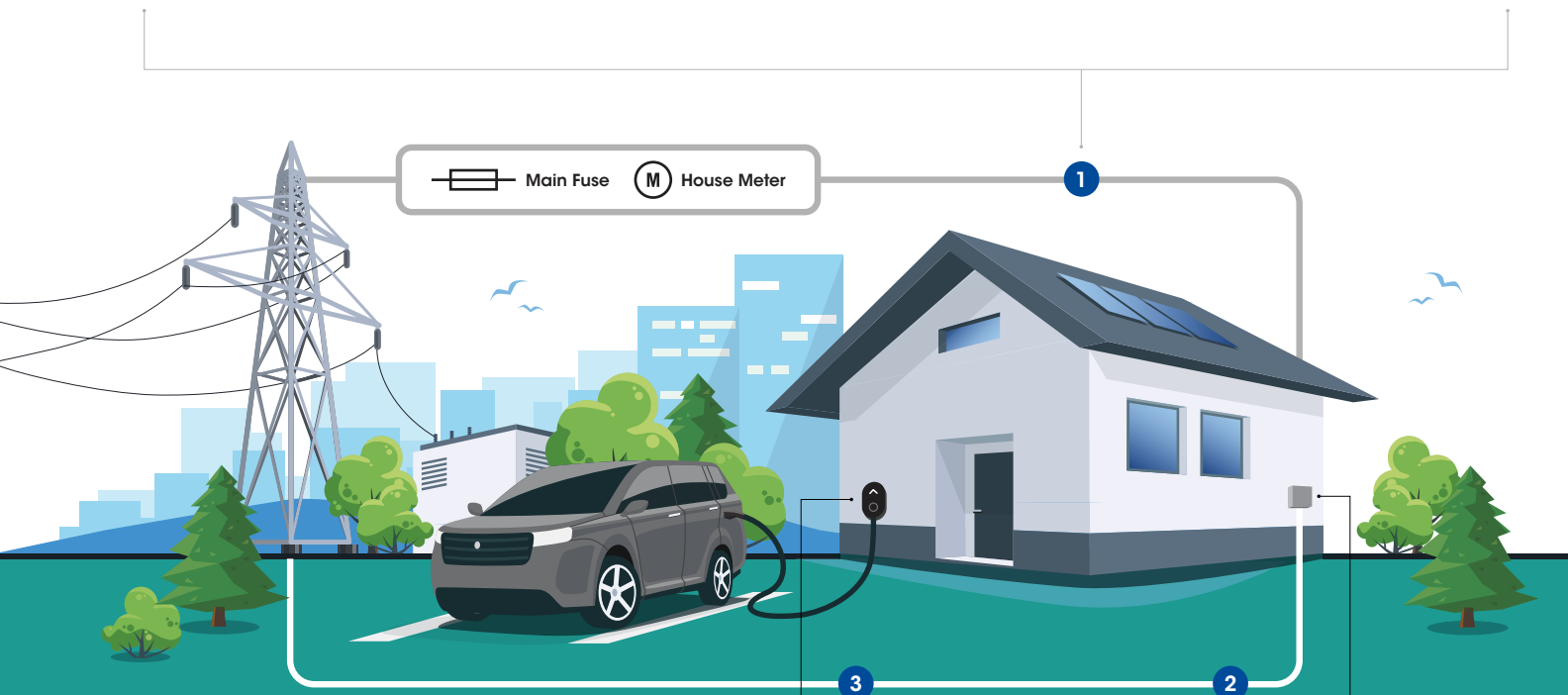

Scan the QR Code to Explore our EV SOLUTIONS!

SIENA

- 7.4kW Single Phase and 22kW Three Phase AC 32A Chargers.
- Mode 3 EV Fast Smart Charging Point.
- Open Charge Point Protocol 1.6.



EV Consumer Unit

- Populated with a 100A 2P main switch, a type 2 surge protection device, and a B40A 1P 6kA MCB, plus a bi-directional Type A 30mA RCD.
- IP65-rated.
- Available in metal and polycarbonate enclosures.





Bi-directional RCBOs

- 6kA range - TYPE A, B-Curve Bidirectional RCBOs.
- Available in 6A - 40A current ratings.



MCBs

- 6kA range is available in 1/2/3/4 Poles in B & C trip curves from 6A-63A.
- 10kA range is available in 1/2/3 Poles in B/C/D trip curves from 6A-63A current ratings.



Main switch

- Available in 2 Pole for 6kA range and 3/4 Pole for 10kA range.



SPDs

- Type 1 and Type 2 surge protection devices designed for various applications - suitable for single or three-phase applications.
- They are compatible with both TN (TN-S & TN-C-S) and TT earthing arrangements.



TP&N Distribution Boards

- Designed & Engineered in the UK
- Four modular sizes available: 4, 8, 12 & 16 TP outgoing ways.
- Compatible with the 6kA & 10kA circuit protection range.
- All steel construction finished with a powder coating in RAL9003, white.

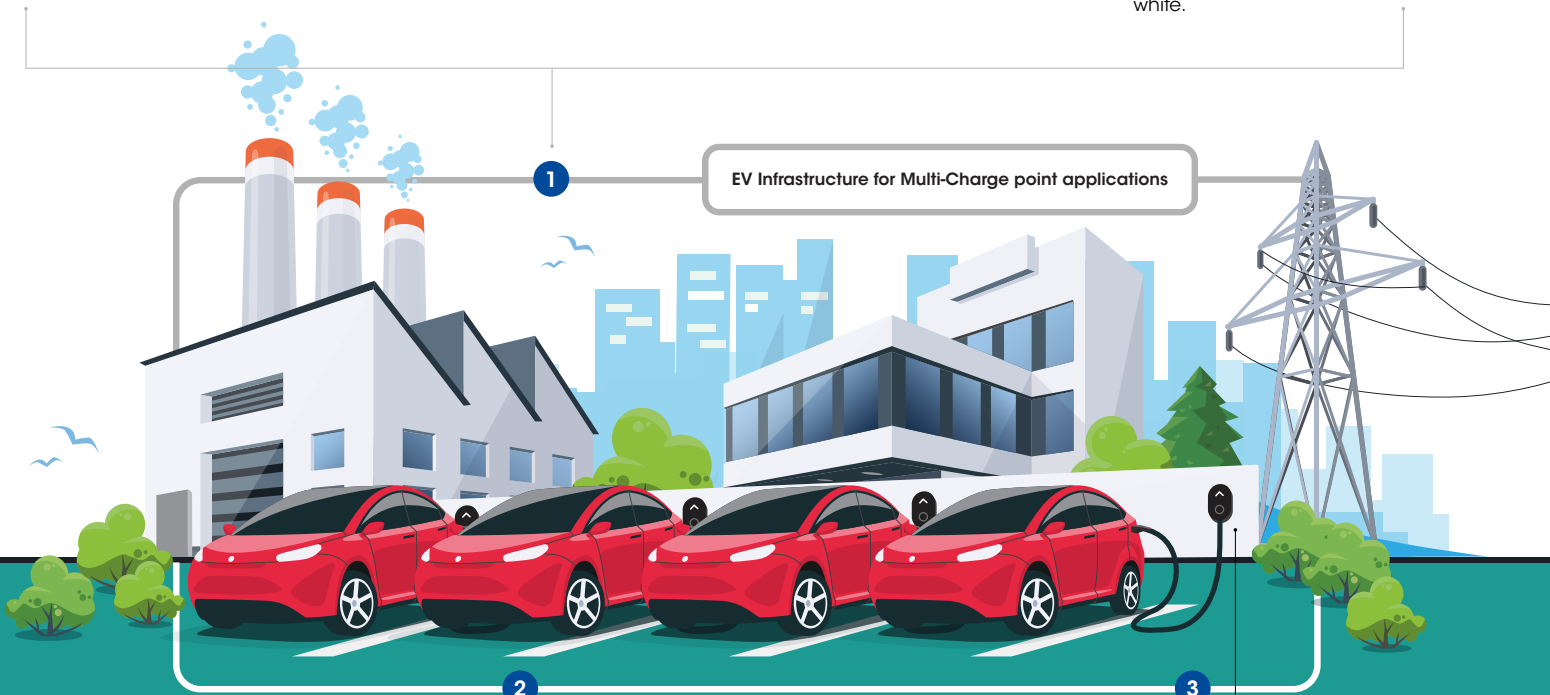

EV Feeder Pillars

- Customizable Distribution Cabinets for Multiple EV Charging.
- The standard range is available in five different current ratings 100A, 125A, 200A, 400A & 630A in Metal or GRP.
- We CUSTOMIZE AS YOU WISH!



SIENA

- 7.4kW Single Phase and 22kW Three Phase AC 32A Chargers.
- Mode 3 EV Fast Smart Charging Point.
- Open Charge Point Protocol 1.6.



WHERE TO BUY?

Find your preferred supplier from a network of trusted sellers where you can purchase Lewden products and accessories.



Scan the QR code to find your nearest stockist.

FOR SPECIAL ENQUIRY CONTACT

Headoffice, LEWDEN LTD
Unit 4, Bradbury Drive,
Springwood Industrial Estate,
Braintree Essex CM7 2SD
+44 (0) 1376 336 200
sales@lewden.co.uk



Lead of Customer Engagement & Partnerships
+44 (0) 7973 838 465
sam.mcgimpsey@lewden.co.uk

Lead of Renewable & Safety Solutions
+44 (0) 7384 818 813
jodie.williams@lewden.co.uk

FOR TECHNICAL SUPPORT

+44 (0) 3308 225 285

- Online Guides
<https://monta.com/en/help-center/>
- Customer Contact
<https://monta.com/en/contact/>
- Within Monta App
[/me/support](#)



Lewden EV Support Engineer
WhatsApp Support Line
+44 (0) 7764 293 501
evcharging@lewden.co.uk



The Electricians' Choice

Tel.: +44 (0) 1376 336 200 | sales@lewden.co.uk | [lewden.com](https://www.lewden.com)



Lewden_Elec



Lewden - Palazzoli Group



Lewden



@lewdenpalazzoli



@lewdenltd